



ASFORS®
ENDÜSTRİ ALÜMİNYUM MİMARİ VE KORKULUK SİSTEMLERİ

Ürün Katalođu

Product Catalog

**ALUMINUM
ARCHITECTURAL
AND RAILING SYSTEMS**



ASFORS

Baęlantı Elemanlarında Güven ve Kalite

Asfors, cam balkon, pencere ve yapı sistemleri için alüminyum baęlantı elemanları üreten, sektörün ihtiyaçlarına yenilikçi ve güvenilir çözümler sunan bir markadır. +100 ürün çeşidimize, kullanıcılarımızın her türlü baęlantı ihtiyacına en doğru çözümleri sağlıyoruz.

Yüksek kaliteli malzemelerle tasarlanan ürünlerimiz, dayanıklılık, estetik ve kolay montaj gibi avantajlarıyla öne çıkar. Müşteri memnuniyetini ön planda tutarak, üretim sürecimizin her aşamasında uluslararası standartlara uygunluk sağlıyoruz.yenilikçi çözümler sağlamaktadır.

Trust and Quality in Fastening Elements

Asfors is a brand that manufactures aluminum fastening elements for glass balconies, windows, and building systems, offering innovative and reliable solutions to meet industry needs.

With a product range of over 100 varieties, we provide the most accurate solutions for all fastening requirements.

Designed with high-quality materials, our products stand out with their durability, aesthetics, and ease of installation. Prioritizing customer satisfaction, we ensure compliance with international standards at every stage of our production process.



İÇİNDEKİLER / CONTENTS

Kare Sistem / Square System	01 - 14
Kare Ürünler / Square Products	03 - 04
14 x 14 Ürünler / 14 x 14 Products	05 - 06
60 x 25 Ürünler / 60 x 25 Products	07 - 09
40 x 25 Ürünler / 40 x 25 Products	10
40 x 40 Ürünler / 40 x 40 Products	11 - 12
80 x 30 Ürünler / 80 x 30 Products	13 - 14

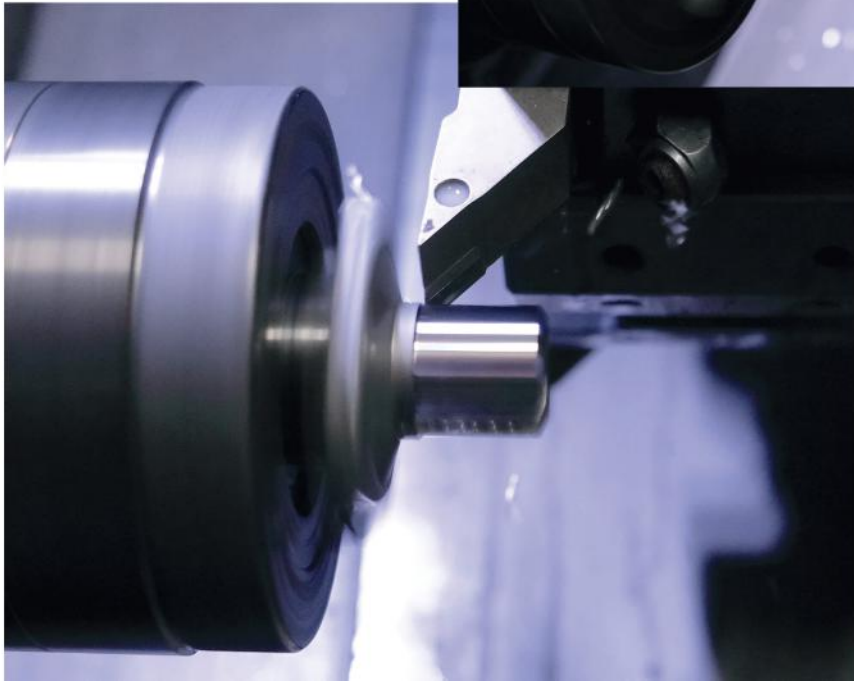

KARE SİSTEM

SQUARE SYSTEM

ASFORS Endüstri'nin Kare Sistem kategorisinde yer alan 16'lık, 20'lik, 25'lik, 30'luk, 40'lık ve 50'lik kare alüminyum profiller, farklı ölçü ve teknik özellikleriyle geniş kullanım alanı sunmaktadır. Yüksek kalite standartlarında üretilen bu profiller, sağlam yapısı, estetik tasarımı ve kolay montaj avantajlarıyla yapı ve endüstriyel projelerde güvenilir bir çözüm sağlar.

16'lık ve 20'lik kare profiller, hafif ve şık tasarımlarıyla dekoratif uygulamalarda ön plana çıkarken, 25'lik ve 30'luk kare profiller, hem yapısal hem de estetik gereksinimleri karşılayan dayanıklı çözümler sunar. Daha büyük ölçekli projeler için ise 40'lık ve 50'lik kare profiller, yüksek mukavemetli yapılarıyla maksimum dayanıklılık ve güvenlik sağlar.

ASFORS Endüstri, geniş ürün yelpazesıyla kare sistem profilleri sayesinde modern, yenilikçi ve uzun ömürlü çözümler sunarak projelerinizin en iyi şekilde tamamlanmasını sağlamayı hedeflemektedir.



- **Kare Ürünler** / Square Products
- **14 x 14 Ürünler** / 14 x 14 Products
- **60 x 25 Ürünler** / 60 x 25 Products
- **40 x 25 Ürünler** / 40 x 25 Products
- **40 x 40 Ürünler** / 40 x 40 Products
- **80 x 30 Ürünler** / 80 x 30 Products



• Kare Ürünler

ASFORS Endüstri'nin Kare Profil kategorisinde, çeşitli ölçü ve özelliklere sahip alüminyum profiller bulunmaktadır. Ürün yelpazesi arasında 14x14, 40x25, 40x40, 60x25 ve 80x30 mm ebatlarındaki profiller mevcuttur. Bu profiller, önden kanallı, ortadan kanallı, kanalsız ve kapaksız seçenekleriyle sunulurken, farklı bağlantı ihtiyaçlarınıza uyum sağlar.

Ayrıca, cam kanal profilleri ve gemici profilleri gibi özel tasarımlar, yapı sistemlerinde estetik, dayanıklılık ve kolay montaj avantajı sunar. ASFORS Endüstri, yüksek kalite standartlarında üretilen ürünleriyle yapı ve dekorasyon projeleriniz için güvenilir ve yenilikçi çözümler sağlamaktadır.

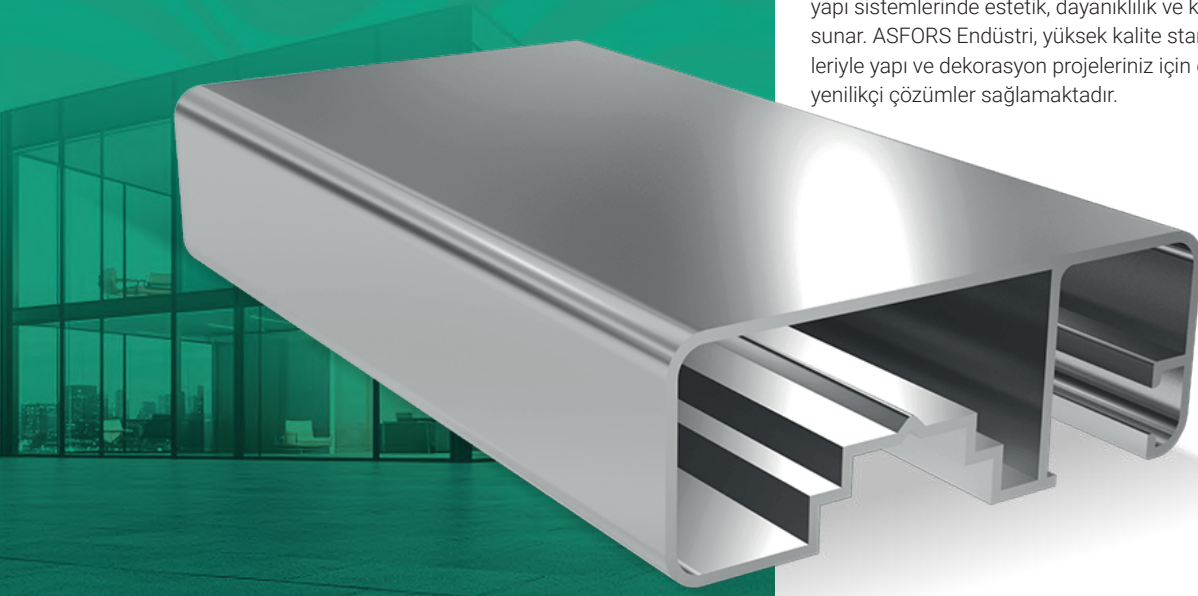

ASK - 001

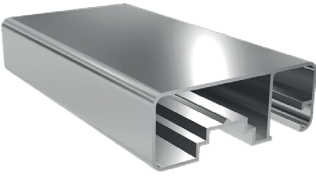

80X30 Kare Profil Önden Kanallı
80X30 Square Profile with Front Channel

ASK - 002



40x25 Kare Profil Kapaksız
40x25 Square Profile Without Cover

ASK - 003

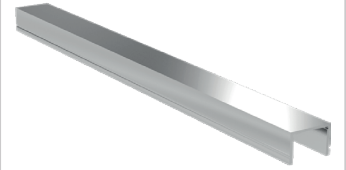

Dikme Çıtası
Strut Lath

ASK - 004



Cam Kanal Profili Uzun 12 mm.
Glass Channel Profile Long 12 mm.

ASK - 005



Cam Kanal Profili Uzun 8 mm.
Glass Channel Profile Long 8 mm.

ASK - 006



Cam Kanal Profili 12 mm.
Glass Channel Profile 12 mm.

ASK - 007

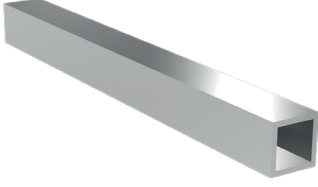

14x14 Kare Profil
14x14 Square Profile

ASK - 008

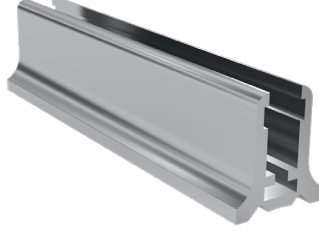

40x25 Kare Profil Tek Kanallı
40x25 Square Profile Single Channel

ASK - 009

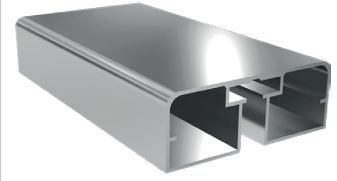

80x30 Kare Profil Ortadan Kanallı
80x30 Square Profile with Central Channel

ASK - 010

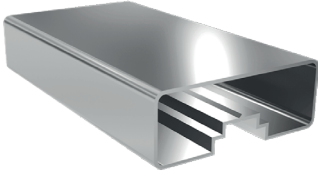

80x30 Kare Profil Kanalsız
80x30 Square Profile Without Channel

ASK - 011

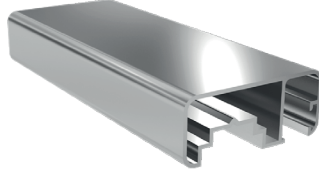

60x25 Kare Profil Önden Kanallı
60x25 Square Profile with Front Channel

ASK - 012

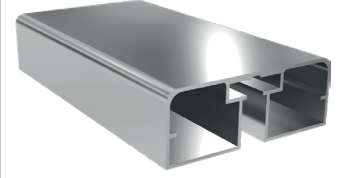

60x25 Kare Profil Ortadan Kanallı
60x25 Square Profile with Central Channel

ASK - 013

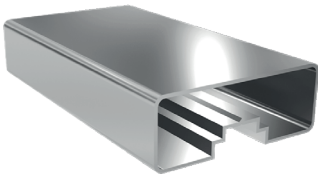

60x25 Kare Profil Kanalsız
60x25 Square Profile Without Channel

ASK - 014

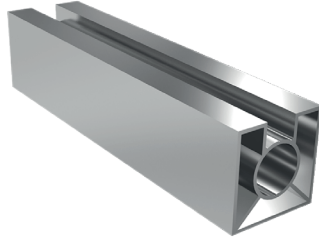

40x40 Kare Profil Tek Kanallı
40x40 Square Profile Single Channel

ASK - 015

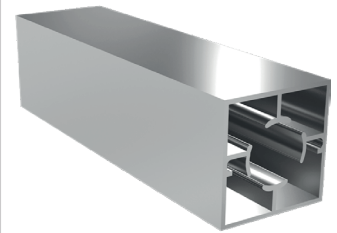

40x40 Kare Profil Kapaksız
40x40 Square Profile Without Cover

ASK - 016

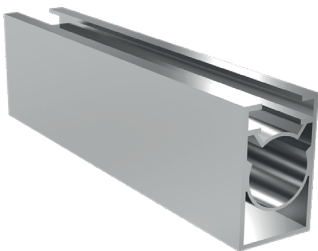

Mini Gemici Profil
Mini Sailor Profile

ASK - 017



Gemici Profil Eco
Gemici Profile Eco

ASK - 018



Gemici Profil
Gemici Profile

• 14 x 14 Ürünler

ASFORS Endüstri'nin Kare Profil kategorisinde, 14x14 mm ebatlarında alüminyum profiller bulunmaktadır. Bu profiller, önden kanallı, ortadan kanallı, kanalsız ve kapaksız seçenekleriyle sunulur, farklı bağlantı ihtiyaçlarınıza uyum sağlar.

Ayrıca, cam kanal profilleri ve gemici profilleri gibi özel tasarımlar, yapı sistemlerinde estetik, dayanıklılık ve kolay montaj avantajı sunar. ASFORS Endüstri, yüksek kalite standartlarında üretilen ürünleriyle yapı ve dekorasyon projeleriniz için güvenilir ve yenilikçi çözümler sağlamaktadır.

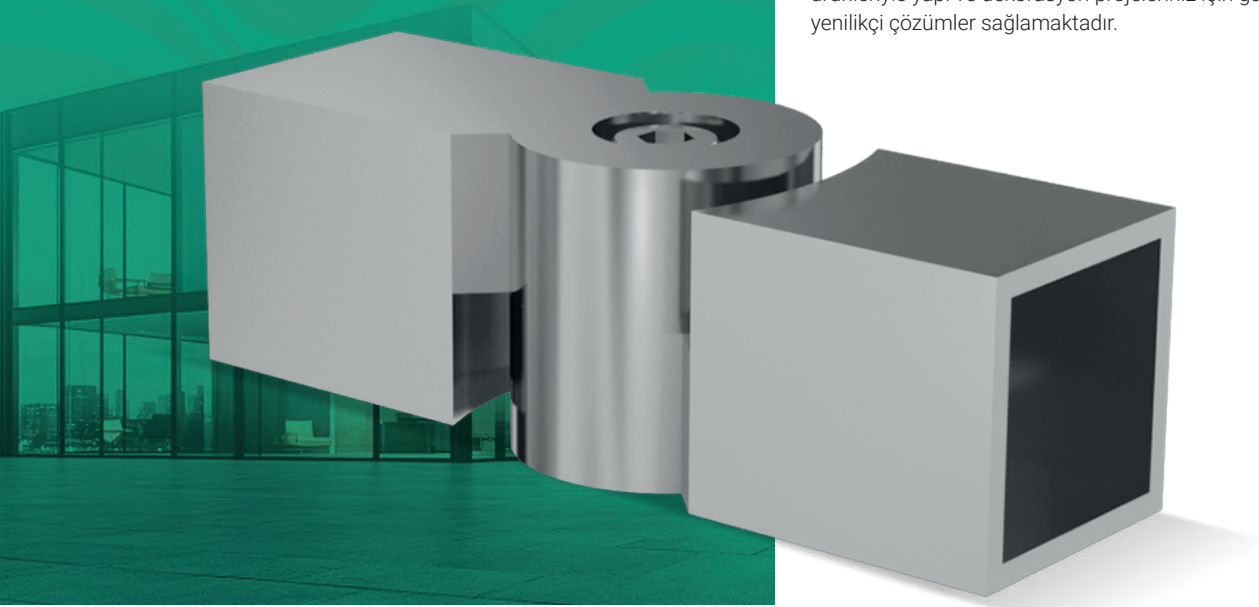

ASK - 019



14x14 Kare 90° Derece Dirsek
14x14 Square 90° Degree Elbow

ASK - 020



14x14 Kare 45 Derece Dirsek
14x14 Square 45 Degree Elbow

ASK - 021



14x14 Bilezik
14x14 Bracelet

ASK - 022

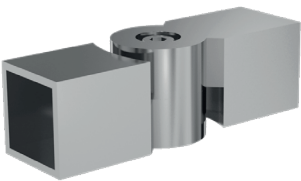

14x13 Topuz Dirsek Dolu
14x13 Knob Elbow Full

ASK - 023

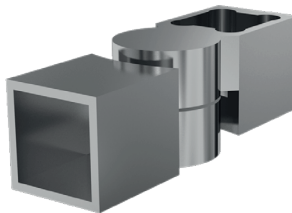

14X14 Topuz Dirsek Merdiven
14X14 Knob Elbow Ladder

ASK - 024

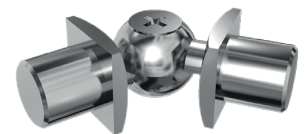

14x14 Topuz Dirsek
14x14 Knob Elbow

ASK - 025



14x14 Topuz Dirsek Dışa Geçme
14x14 Knob Elbow Outgoing

ASK - 026



14x14 Emniyet Tutamağı
14x14 Safety Handle

ASK - 027

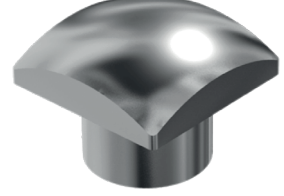

14x14 Tapa
14x14 Plug

ASK - 028



14x14 Kare Kubbe Tapa
14x14 Square Dome Stopper

ASK - 029



14x14 KareVida Gizleme Tapası
14x14 Square Screw Hiding Plug

ASK - 030



14x14 Kare Jumbo
14x14 Square Jumbo



• 60 x 25 Ürünler

ASFORS Endüstri'nin ürün portföyünde bulunan 60x25 mm alüminyum profiller, geniş kullanım alanlarına uygun olarak tasarlanmıştır. Önden kanallı, ortadan kanallı, kanalsız ve kapaksız seçenekleriyle her türlü bağlantı ihtiyacına cevap verir.

Ayrıca, cam kanal ve gemici profilleri gibi özel tasarımlar, yapı sistemlerinde hem şıklık hem de dayanıklılık sağlarken, kolay montaj özellikleriyle kullanımı kolaylaştırır. ASFORS Endüstri, yüksek kalite standartlarında ürettiği bu profillerle, yapı ve dekorasyon projelerinizde yenilikçi ve güvenilir çözümler sunmaktadır.



ASK - 031



60x25 90° Dirsek
60x25 90° Elbow

ASK - 032

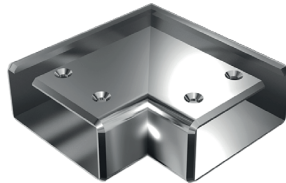

60x25 90° Dirsek Önden Kanallı
60x25 90° Elbow Front Channel

ASK - 033



60x25 90° Dirsek Ortadan Kanallı
60x25 90° Elbow Center Channel

ASK - 034

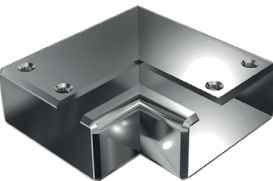

60x25 90° Dirsek İçten Kanallı
60x25 90° Elbow Internal Channel

ASK - 035



60x25 90° Dirsek 45x90
60x25 90° Elbow 45x90

ASK - 036



40x25 90° Dirsek 45x90x45
40x25 90° Elbow 45x90x45

ASK - 037



60x25 45° Dirsek
60x25 45° Elbow

ASK - 038

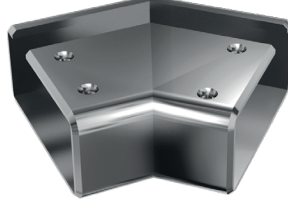

60x25 45° Dirsek Önden Kanallı
60x25 45° Elbow Front Channel

ASK - 039



60x25 45° Dirsek Ortadan Kanallı
60x25 45° Elbow Center Channel

ASK - 040



60x25 45° Dirsek İçten Kanallı
60x25 45° Elbow Internal Channel

ASK - 041



60x25 Yatay Topuz Dirsek
60x25 Horizontal Knob Elbow

ASK - 042

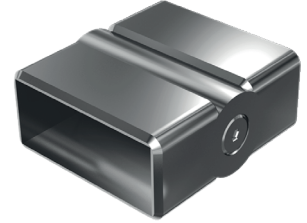

60x25 Dik Açılı Dirsek
60x25 Right Angle Elbow

ASK - 043



60x25 90° Sabit Dik Açılı
60x25 90° Fixed Right Angle

ASK - 044



60x25 45° Bilyalı Topuz Dirsek
60x25 45° Ball Ball Elbow

ASK - 045

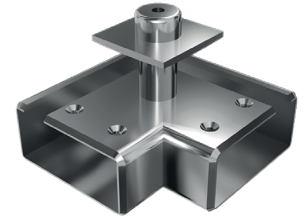

60x25 Üçlü 90° Dirsek
60x25 Triple 90° Elbow

ASK - 046



60x25 Üçlü 90° Dirsek 45x90
60x25 Triple 90° Elbow 45x90

ASK - 047



60x25 Üçlü 90° Dirsek 45x90x45
60x25 Triple 90° Elbow 45x90x45

ASK - 048

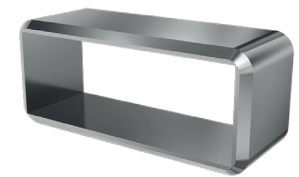

60x25 Bilezik
60x25 Bracelet

ASK - 049



60x25 Bilezik Kanallı
60x25 Bracelet Channel

ASK - 050

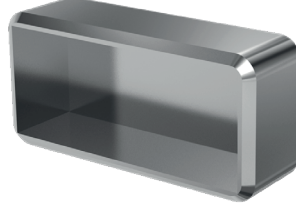

60x25 Kare Dıştan Tapa
60x25 Square External Plug

ASK - 051

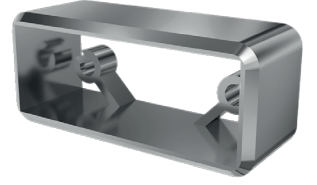

60x25 İçten Vidalı Duvar Flanşı
60x25 Internal Screw Wall Flange

ASK - 052

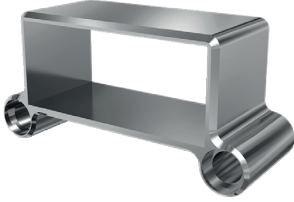

60x25 Duvar Flanşı Yandan Delikli
60x25 Wall Flange Side Perforated

ASK - 053

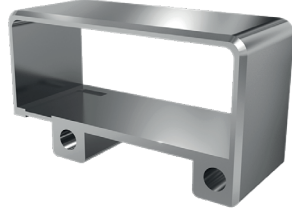

60x25 Duvar Flanşı Sağ
60x25 Wall Flange Right

ASK - 054

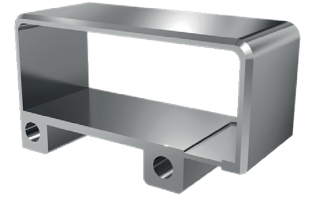

60x25 Duvar Flanşı Sol
60x25 Wall Flange Left

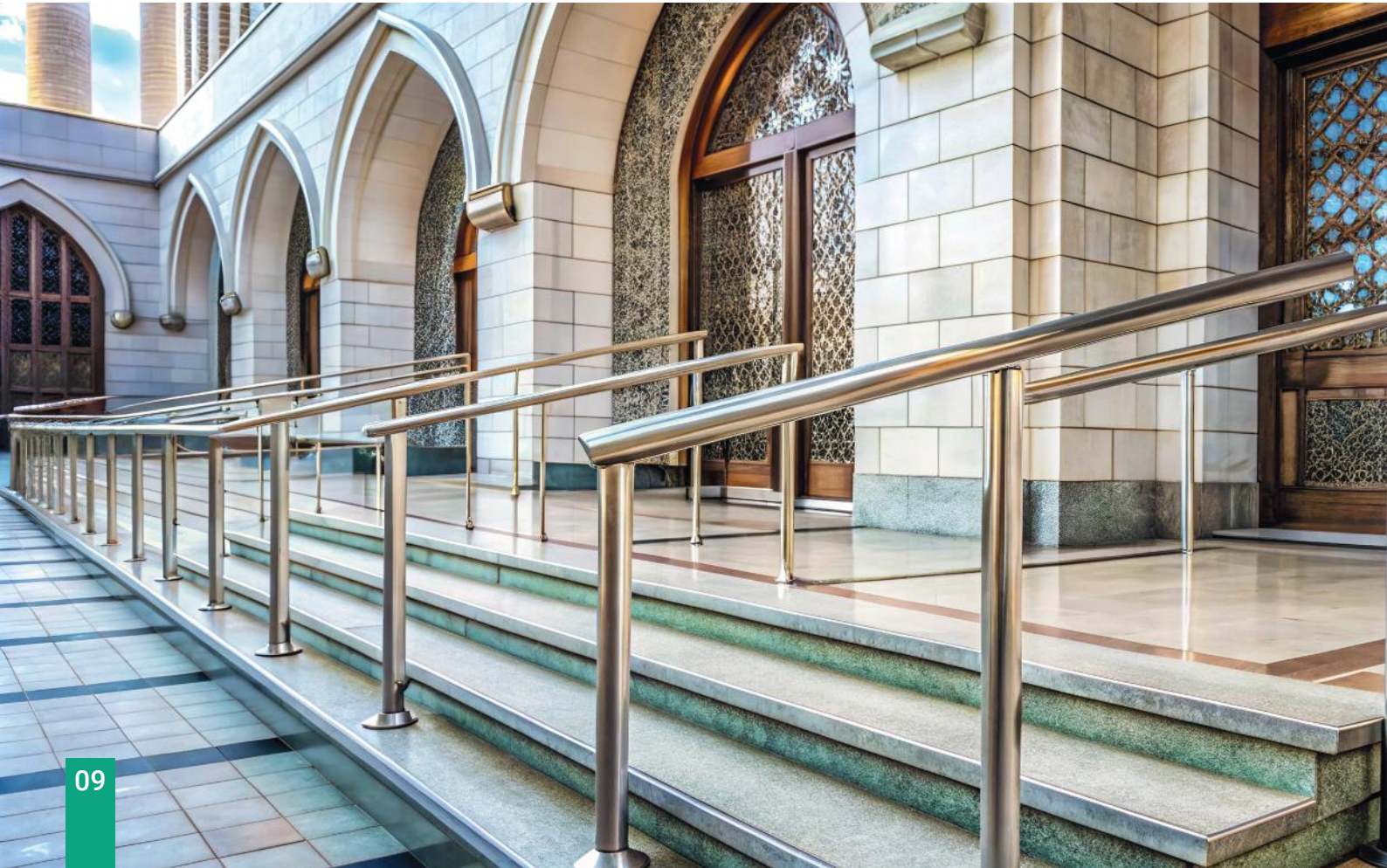

• 40 x 25 Ürünler

ASFORS Endüstri'nin Kare Profil koleksiyonunda, 40x25 mm ölçülerindeki alüminyum profiller öne çıkmaktadır. Bu profiller, farklı ihtiyaçlara uygun şekilde önden kanallı, ortadan kanallı, kanalsız ve kapaksız alternatiflerle sunulmaktadır.

Bunun yanı sıra, cam kanal ve gemici profilleri gibi özel tasarımlar, yapı sistemlerinde hem estetik hem de dayanıklılık sunarken, kolay montaj özelliği ile kullanımı pratik hale getirir. ASFORS Endüstri, yüksek kalite standartlarıyla ürettiği bu profillerle, yapı ve dekorasyon projelerinize modern ve güvenilir çözümler sunmayı amaçlamaktadır.



ASK - 055



40x25 Kare Oynar Başlık
40x25 Square Movable Head

ASK - 056



40x25 Kare Lamalı Oynar Başlık
40x25 Square Laminate Moving Head

ASK - 057



40x25 Kare Kadeh Başlık Oval
40x25 Square Goblet Cap Oval

ASK - 058

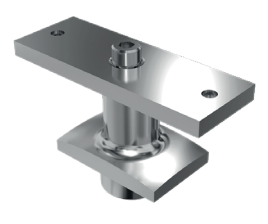

40x25 Kare Lamalı Başlık
40x25 Square Laminated Headboard

ASK - 059

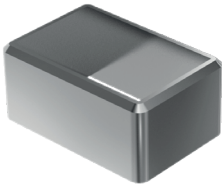

40x25 Kare Profil Pahlı Rozet
40x25 Square Profile Chamfered Rosette

ASK - 060

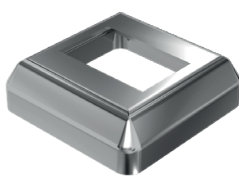

40x25 Profil Sac Rozet
40x25 Profile Sheet Rosette

ASK - 061



40x25 Uzun Yargılı Pahlı Rozet
40x25 Long Trim Chamfered Rosette

ASK - 062

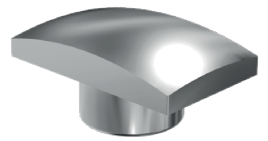

40x25 Tapa
40x25 Plug

• 40 x 40 Ürünler

ASFORS Endüstri'nin ürün seçenekleri arasında yer alan 40x40 mm alüminyum profiller, farklı projelere uyum sağlayacak şekilde tasarlanmıştır. Önden kanallı, ortadan kanallı, kanalsız ve kapaksız alternatifleriyle her türlü bağlantı ihtiyacınızı karşılar.

Cam kanal ve gemici profilleri gibi özel çözümler, estetik ve dayanıklılığı bir araya getirirken, kolay montaj imkânı ile kullanım kolaylığı sunar. ASFORS Endüstri, yüksek kalite standartlarına sahip bu profilleriyle yapı ve dekorasyon projelerinizde modern ve güvenilir çözümler sunmaya devam etmektedir.

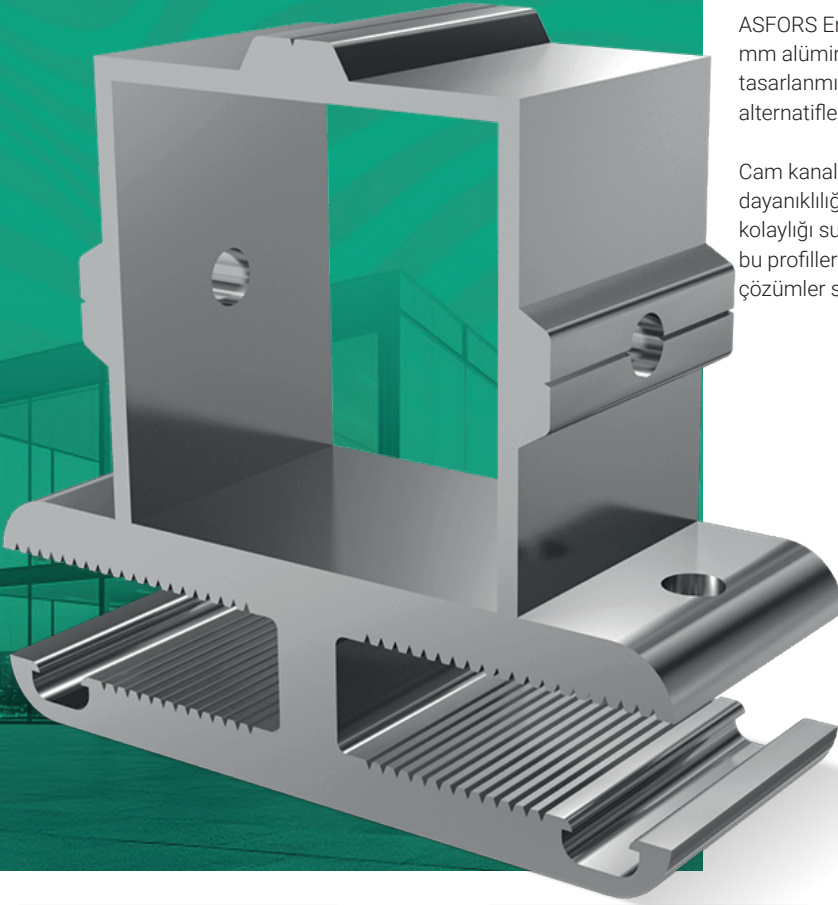

ASK - 063



40x40 Kare Oynar Başlık
40x40 Square Movable Head

ASK - 064



40x40 Kare Oynar Başlık Dolu
40x40 Square Pivoting Head Full

ASK - 065



40x40 Lamalı Oynar Başlık
40x40 Flat Head

ASK - 066



40x40 Kare Lamalı Oynar Başlık Dolu
40x40 Square Laminate Moving Head Full

ASK - 067

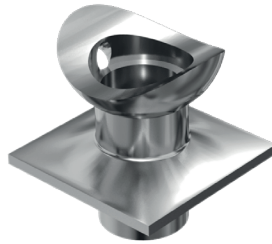

40x40 Sabit Başlık Oval
40x40 Fixed Head Oval

ASK - 068

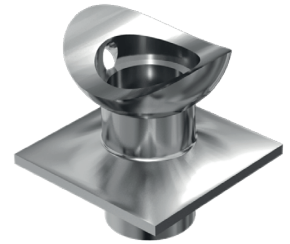

40x40 Sabit Başlık Oval Dolu
40x40 Fixed Head Oval Filled

ASK - 069



40x40 Kare Lamalı Başlık Somunlu
40x40 Square Flat Head with Nut

ASK - 070



40x40 Kare Lamalı Başlık
40x40 Square Laminated Headboard

ASK - 071

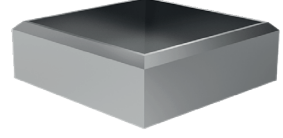

40x40 Kare Profil Pahlı Rozet
40x40 Square Profile Chamfered Rosette

ASK - 072

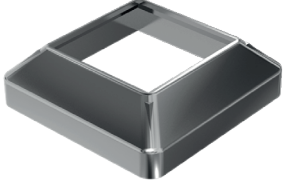

40x40 Kare Profil Saç Rozet
40x40 Square Profile Hair Rosette

ASK - 073



40x40 Yandan Bağlantı U
40x40 Side Connection U

ASK - 074



40x40 Kare 3'lü Hareketli Küre Dirsek
40x40 Square Triple Movable Sphere Elbow

ASK - 075

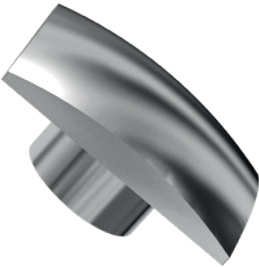

40x40 Kare Profil Tapa
40x40 Square Profile Plug

ASK - 076



40x40 Kare Topuz
40x40 Square Knob

ASK - 077



40x40 Kare Kubbe Topuz
40x40 Square Dome Knob

ASK - 078



40x40 Bilezikli Cam Aparatı Çiftli
40x40 Bracelet Glass Apparatus Double

ASK - 079

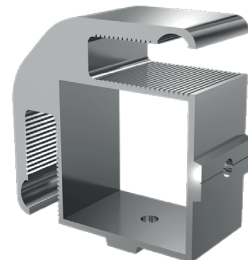

40x40 Bilezikli Cam Aparatı Köşe
40x40 Bracelet Glass Apparatus Corner

• 80 x 30 Ürünler

ASFORS Endüstri'nin geniş ürün yelpazesi içinde yer alan 80x30 mm alüminyum profiller, farklı projelerinize uyum sağlayacak şekilde tasarlanmıştır. Önden kanallı, ortadan kanallı, kanalsız ve kapaksız seçenekleriyle çeşitlilik sunarak bağlantı ihtiyaçlarınızı eksiksiz karşılar.

Cam kanal ve gemici profilleri gibi özel tasarımlar, yapı sistemlerinize estetik ve dayanıklılık katarken, kolay montaj avantajı sağlar. ASFORS Endüstri, kalite standartlarından ödün vermeyen bu ürünleriyle yapı ve dekorasyon projelerinizde modern, yenilikçi ve güvenilir çözümler sunmaktadır.

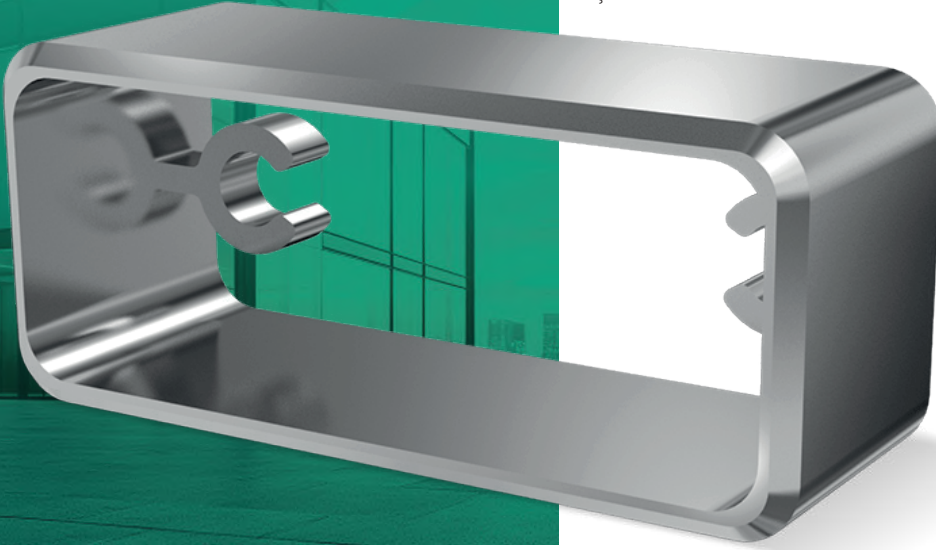

ASK - 080

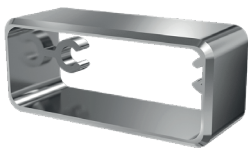

80x30 İçten Vidalı Duvar Flaşı
80x30 Internal Screw Wall Flange

ASK - 081

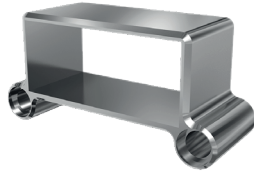

80x30 Duvar Flaşı Yandan Delikli
80x30 Wall Flange Side Perforated

ASK - 082

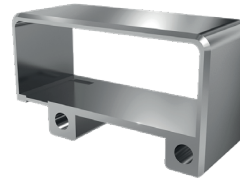

80x30 Duvar Flaşı Sağ
80x30 Wall Flange Right

ASK - 083

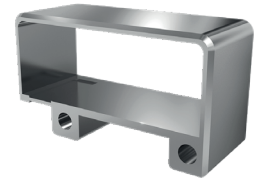

80x30 Duvar Flaşı Sol
80x30 Wall Flange Left

ASK - 084

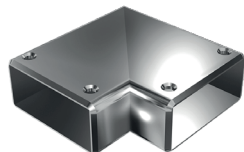

80x30 90° Dirsek
80x30 90° Elbow

ASK - 085



80x30 90° Dirsek Önden Kanallı
80x30 90° Elbow Front Channel

ASK - 086

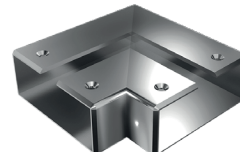

80x30 90° Dirsek Ortadan Kanallı
80x30 90° Elbow Center Channel

ASK - 087

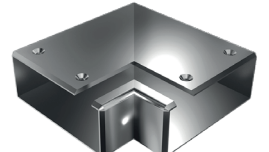

80x30 90° Dirsek İçten Kanallı
80x30 90° Elbow Internal Channel

ASK - 088



80x30 90° Dirsek 45x90
80x30 90° Elbow 45x90

ASK - 089



80x30 90° Dirsek 45x90x45
80x30 90° Elbow 45x90x45

ASK - 090

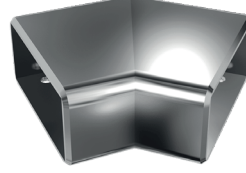

80x30 45° Dirsek
80x30 45° Elbow

ASK - 091

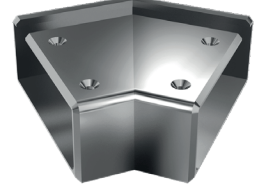

80x30 45° Dirsek Önden Kanallı
80x30 45° Elbow Front Channel

ASK - 092

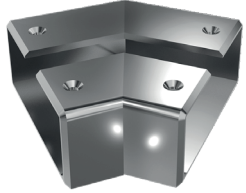

80x30 45° Dirsek Ortadan Kanallı
80x30 45° Elbow Center Channel

ASK - 093



80x30 45° Dirsek İçten Kanallı
80x30 45° Elbow Internal Channel

ASK - 094



80x30 Yatay Topuz Dirsek
80x30 Horizontal Knob Elbow

ASK - 095



80x30 90° Sabit Dik Açılı
80x30 90° Fixed Right Angle

ASK - 096



80x30 Üçlü 90° Dirsek
80x30 Triple 90° Elbow

ASK - 097



80x30 Üçlü 90° Dirsek 45x90
80x30 Triple 90° Elbow 45x90

ASK - 098



80x30 Üçlü 90° Dirsek 45x90x45
80x30 Triple 90° Elbow 45x90x45

ASK - 099



80x30 45° Bilezik
80x30 45° Bracelet

ASK - 100

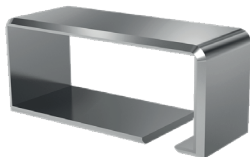

80x30 Bilezik Kanallı
80x30 Bracelet Channel

ASK - 101

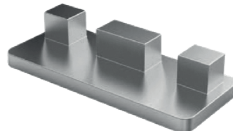

80x30 Kare tapa
80x30 Square plug

ASK - 102

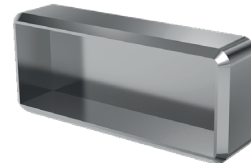

80x30 Kare Dıştan Tapa
80x30 Square External Plug

ALÜMİNYUM MİMARİ VE KORKULUK SİSTEMLERİ



ASFORS Endüstri Alüminyum Mimari
ve Korkuluk Sistemleri

+90 (507) 961 29 98

+90 (533) 791 19 22

www.asfors.com

info@asfors.com

Fevziçakmak Mah., Atiker Koparatif San. Sit.
Ahmet Petekçi Cad, Karatay / KONYA